

PROFILE BLOKUJĄCE SKŁADANE Z ZESTAWEM MONTAŻOWYM

PIPE WITH ASSEMBLY

M321-02



Materiał / Material

1. S235JR
2. 1.4310
3. S235/DC01
4. S235/DC01
5. Miękkie PVC / Soft PVC
6. M6 DIN 934
7. Nit / Rivet Ø5x14 DIN 7337

Jak zamówić / How to order

Symbol: M321-02-070120

Inne wymiary na żądanie
Other dimensions on demand

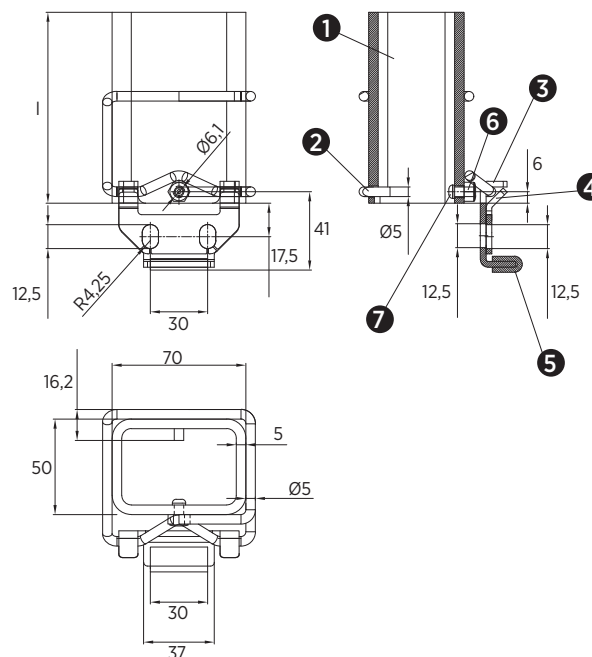

Symbol	l ±0,05	Max Obciążenie Max. load (kN)
M321-02-070065	65	235
M321-02-070070	70	235
M321-02-070075	75	235
M321-02-070080	80	235
M321-02-070085	85	235
M321-02-070090	90	235
M321-02-070095	95	235
M321-02-070100	100	235
M321-02-070105	105	235
M321-02-070110	110	235
M321-02-070115	115	235
M321-02-070120	120	235
M321-02-070125	125	235
M321-02-070130	130	235
M321-02-070135	135	235
M321-02-070140	140	235
M321-02-070145	145	235
M321-02-070150	150	235
M321-02-070155	155	235
M321-02-070160	160	235
M321-02-070165	165	235
M321-02-070170	170	235
M321-02-070175	175	235
M321-02-070180	180	235

Symbol	l ±0,05	Max Obciążenie Max. load (kN)
M321-02-070185	185	235
M321-02-070190	190	235
M321-02-070195	195	235
M321-02-070200	200	235
M321-02-070205	205	235
M321-02-070210	210	235
M321-02-070215	215	235
M321-02-070220	220	235
M321-02-070225	225	235
M321-02-070230	230	235
M321-02-070235	235	235
M321-02-070240	240	235
M321-02-070245	245	235
M321-02-070250	250	235
M321-02-070260	260	235
M321-02-070270	270	235
M321-02-070280	280	235
M321-02-070290	290	235
M321-02-070300	300	235
M321-02-070310	310	235
M321-02-070320	320	235
M321-02-070330	330	235
M321-02-070340	340	235
M321-02-070350	350	235

Elementy transportowe, mocujące i złączne